

Features

- 30Watts peak pulse power ($T_P = 8/20\mu s$)
- DFN2010-5 Package
- Protect up to 4-lines
- Solid-state silicon-avalanche technology
- Low clamping voltage
- Low leakage current
- Low capacitance (0.15pF typical I/O to I/O)
- ESD Protection for high-speed data lines to:
IEC 61000-4-2 ± 8 KV contact ± 15 KV air
IEC 61000-4-4 (EFT) 40A (5/50ns)
IEC 61000-4-5 (Lightning) 3A (8/20 μs)

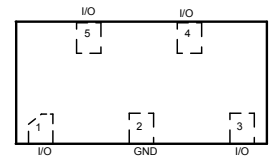
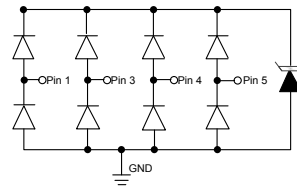
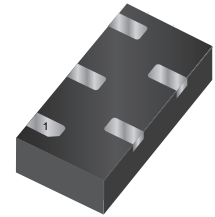

Mechanical Data

- **Case:** DFN2010-5 (plastic package).
Lead free; RoHS compliant; Halogen free
- **Molding Compound Flammability Rating:**
UL 94 V-0
- **Terminals:** High temperature soldering guaranteed:
260 °C/10 sec. at terminals

Applications

- USB 3.0/3.1, Type C
- HDMI 1.4/2.0, Display Port 1.3
- Unified Display interface
- Digital visual interface
- Microcontroller Input Protection

Absolute Maximum Ratings

Ratings at 25 °C, ambient temperature unless otherwise specified

Parameter	Symbol	Value	Unit
Peak Pulse Power ($T_P=8/20\mu s$)	P_{PP}	30	W
ESD contact/air discharge (IEC-61000-4-2)	V_{ESD}	8/15	kV
Peak Pulse Current ($T_P = 8/20\mu s$)	I_{PP}	3	A
Junction Temperature	T_J	-55 to +125	°C
Storage temperature	T_{STG}	-55 to +150	°C

Electrical Characteristics

($T_A = 25\text{ °C}$ unless otherwise specified)

Parameter	Symbol	Condition	Min	Typ	Max	Unit
Reverse stand-off Voltage	V_{RWM}				5	V
Reverse Breakdown Voltage	V_{BR}	$I_T=1\text{mA}$	6	7.2	9.5	V
Reverse Leakage Current	I_R	$V_R=5\text{V}$		0.1	0.5	uA
Clamping Voltage(SURGE)	V_C	$I_{PP}=3\text{A}, T_P=8/20\mu s$		10		V
Junction Capacitance	C_J	$V_R=0\text{V}, f=1\text{MHz}, \text{I/O to I/O}$		0.15		pF
	C_J	$V_R=0\text{V}, f=1\text{MHz}, \text{I/O to GND}$		0.2		pF

Typical Characteristics ($T_{amb} = 25\text{ }^{\circ}\text{C}$ unless otherwise specified)

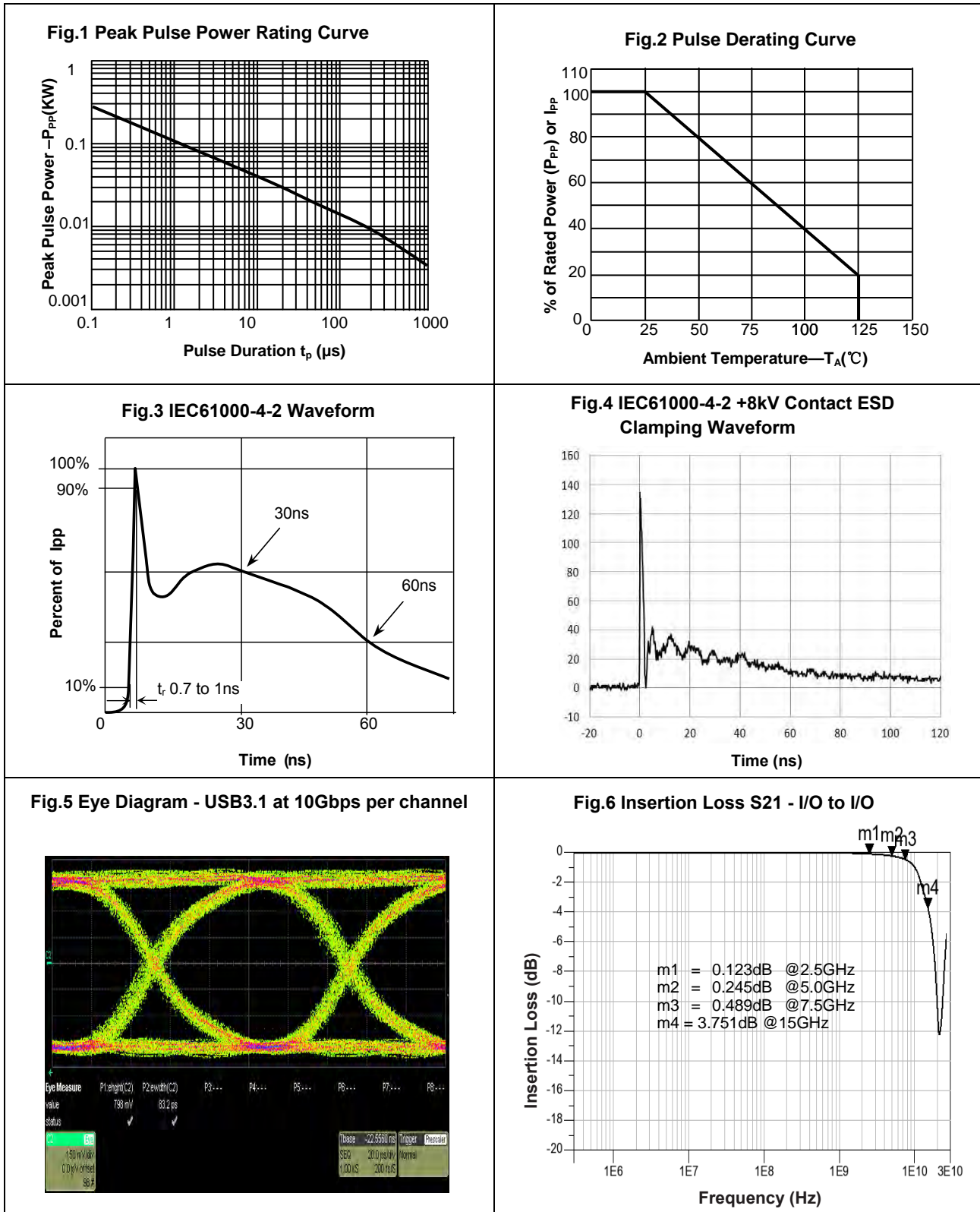

Layout Diagrams

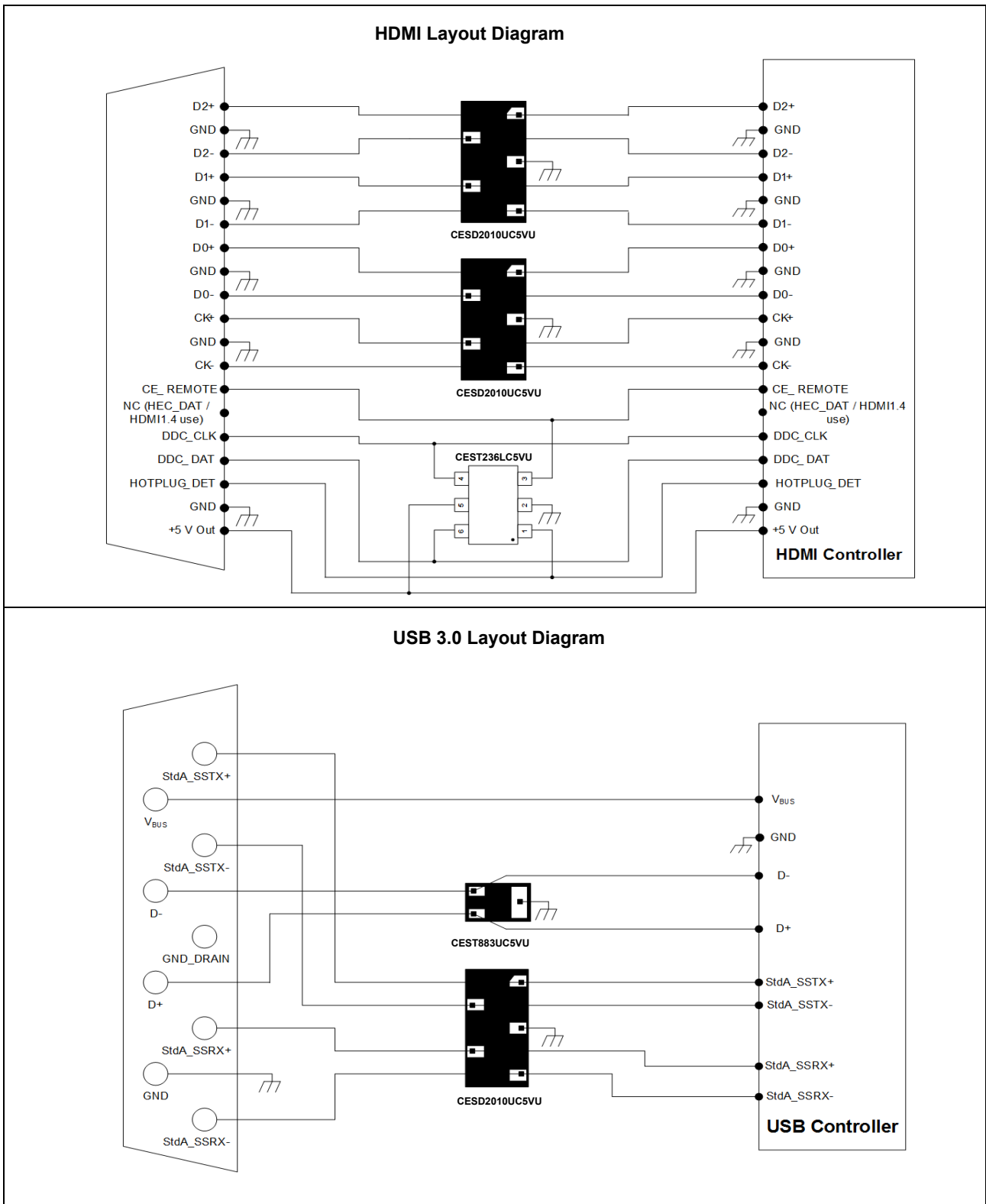

Package Dimensions

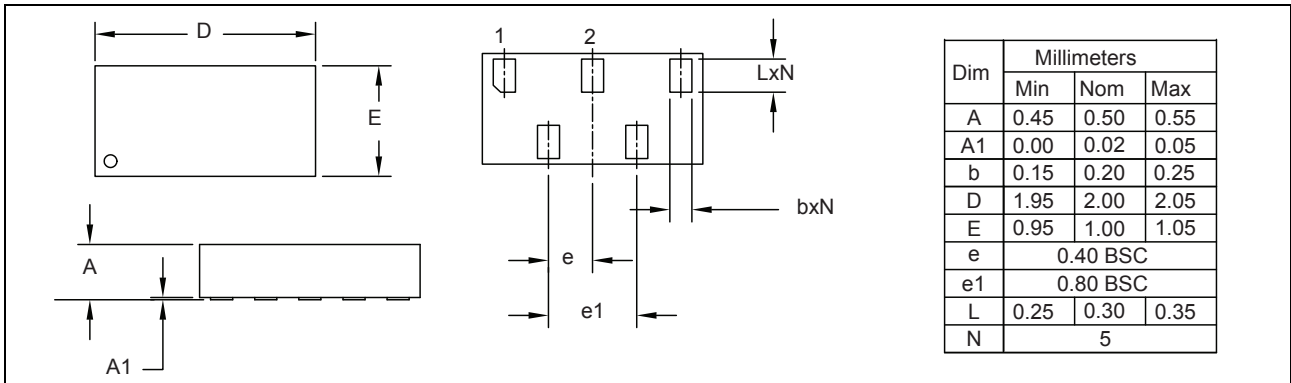

PAD DIMENSIONS

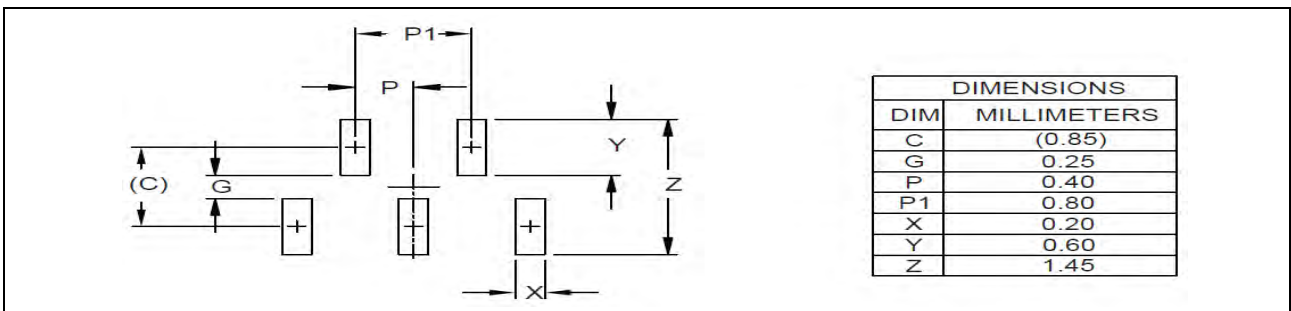

Package Information

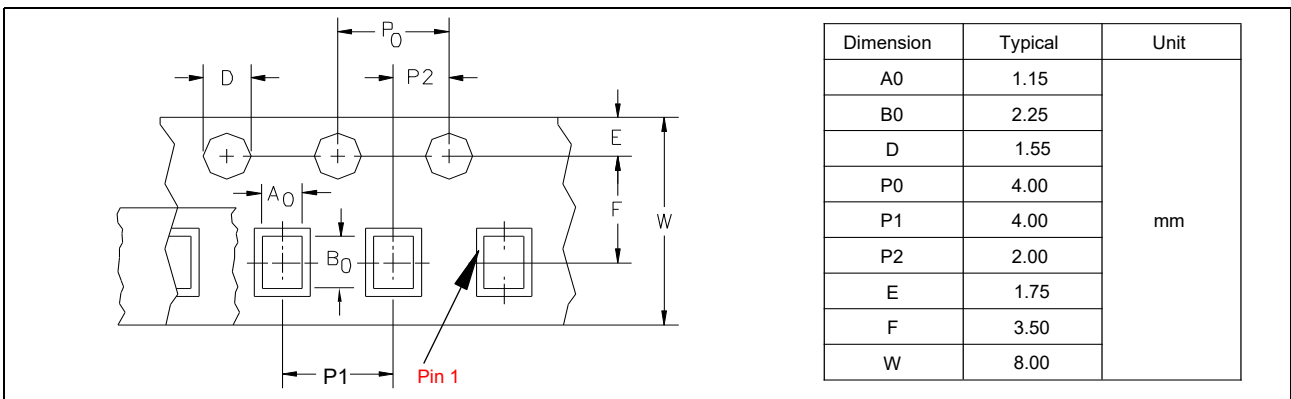

Ordering information

Order code	Marking	Package	Packaging option	Base quantity	Packaging specification
YEU20C50503AV	M534	DFN2010-5	Tape and reel	3000pcs / reel	EIA STD RS-481