

Features

- Very low leakage current
- Fast response time
- Bidirectional configurations
- Very low leakage current
- Response time is typically <math><1\text{ns}</math>
- Extremely low capacitance ($C_j=0.05\text{pF typ.}</math>)$
- The best ESD protection for high frequency, low voltage applications
- Protection one data line to:
IEC 61000-4-2 $\pm 30\text{kV}$ contact $\pm 30\text{kV}$ air

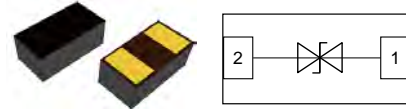

Mechanical Data

- **Case:** P0201 (plastic package).
Lead free; RoHS compliant; Halogen free
- **Molding Compound Flammability Rating:**
UL 94 V-0
- **Terminals:** High temperature soldering guaranteed:
260 °C/10 sec. at terminals

Applications

- USB3.0, Firewire, DVI, HDMI, S-ATA
- Thunderbolt, Display Port
- Mobile HDMI Link, MDDI, MIPI, SWP / NFC



Caution:
This component is designed for signal line protection only,
Not intended to be used under bias, not for application with
a power line.

Absolute Maximum Ratings

Ratings at 25 °C, ambient temperature unless otherwise specified

Parameter	Symbol	Value	Unit
Maximum Contact discharge voltage Per IEC61000-4-2	V_{ESD}	30	kV
Maximum Air discharge voltage Per IEC61000-4-2	V_{ESD}	30	kV
Operating temperature	T_{Oper}	-40 to +125	°C
Storage temperature	T_{STG}	-55 to +125	°C
Maximum Lead Solder Temperature(10 second duration)	T_L	260	°C

Electrical Characteristics

($T_A = 25\text{ °C}$ unless otherwise specified)

Parameter	Symbol	Condition	Min	Typ	Max	Unit
Rated Voltage	V_R	---			30	V
Trigger voltage	V_T	IEC61000-4-2 8KV contact discharge		350		V
Leakage current	I_L	DC 12V shall be applied on component			0.1	uA
Clamping Voltage	V_C	IEC61000-4-2 8KV contact discharge		35		V
Junction Capacitance	C_J	$V_R=0\text{V}, f=1\text{MHz}$		0.05		pF

Note: 1. Trigger and clamping voltage are measured per IEC 61000-4-2, 8KV contact discharge method.

2. After reliability tests such as high temp storage, temp cycles, continuous ESD strike etc, the maximum leakage current is less than 10uA.

ESD Clamping Test

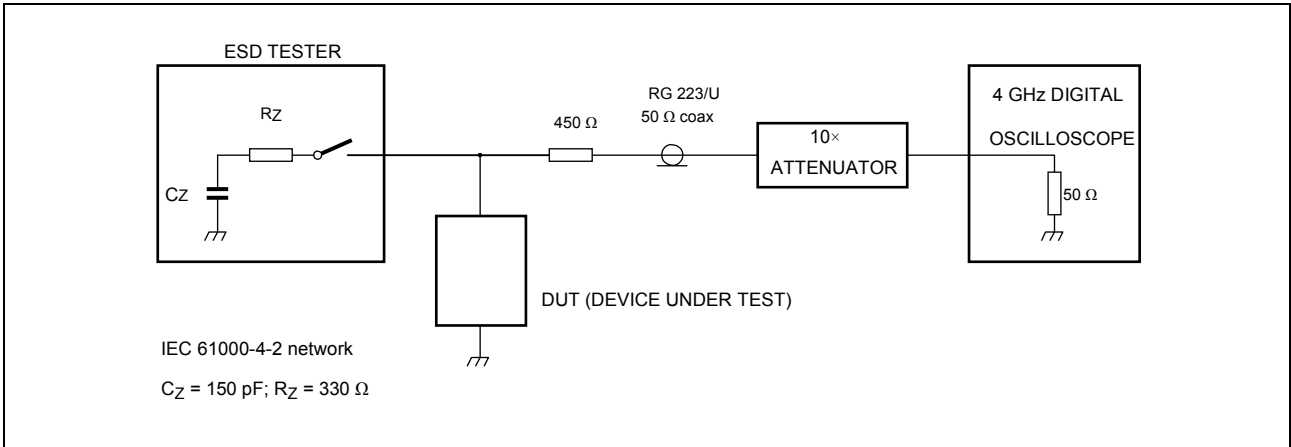

ESD Clamping Test Waveforms

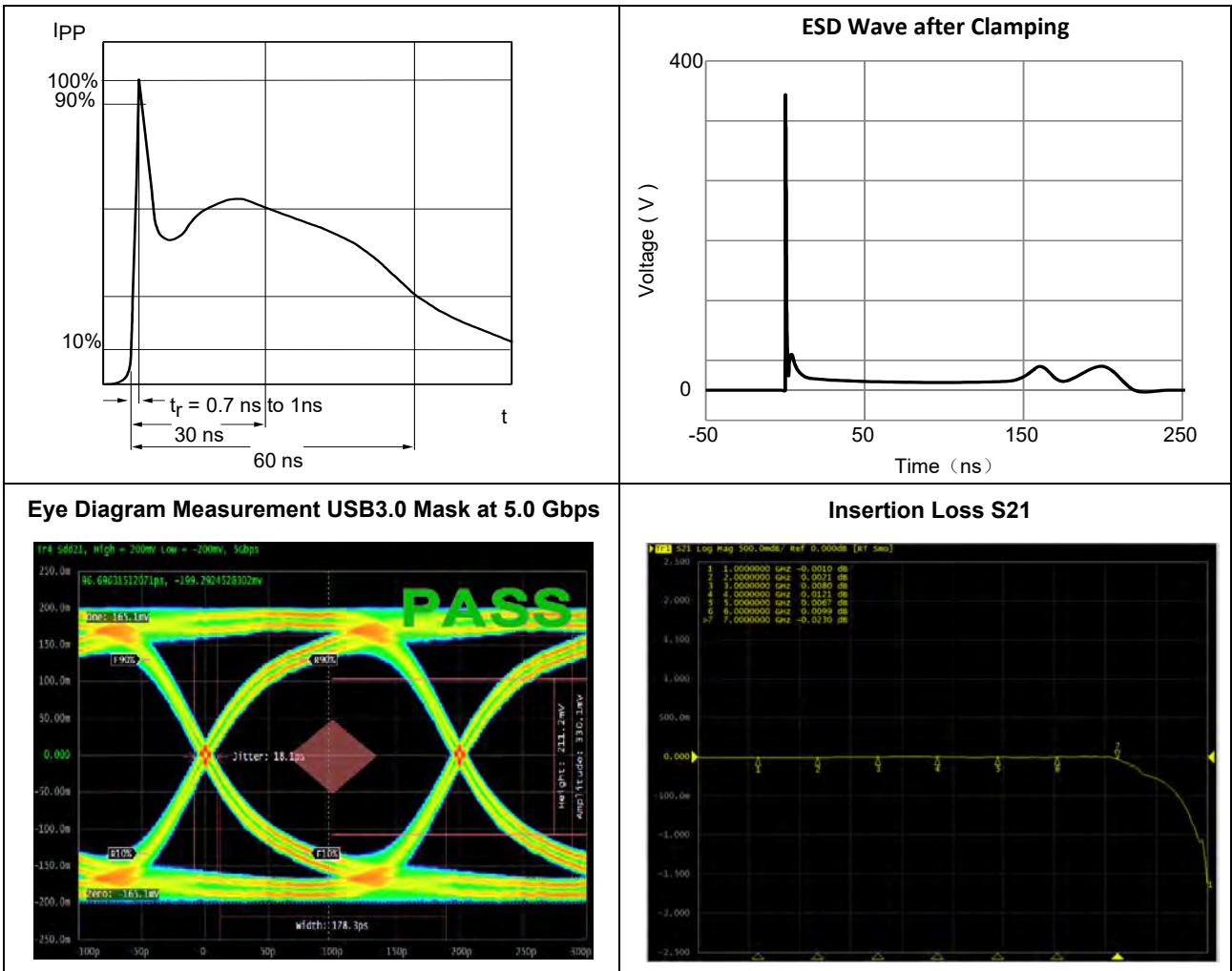

Product Dimension

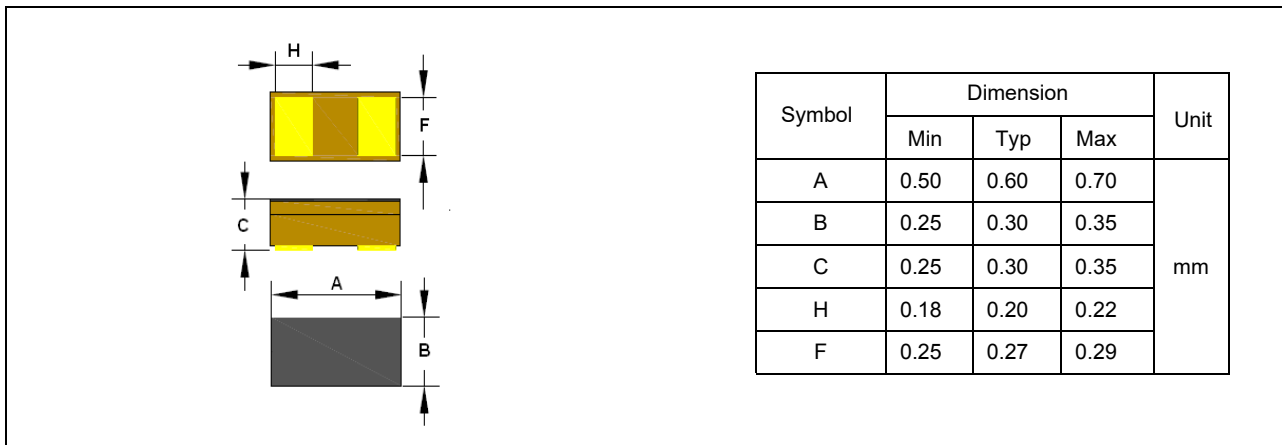

Pad Dimensions



Package Information

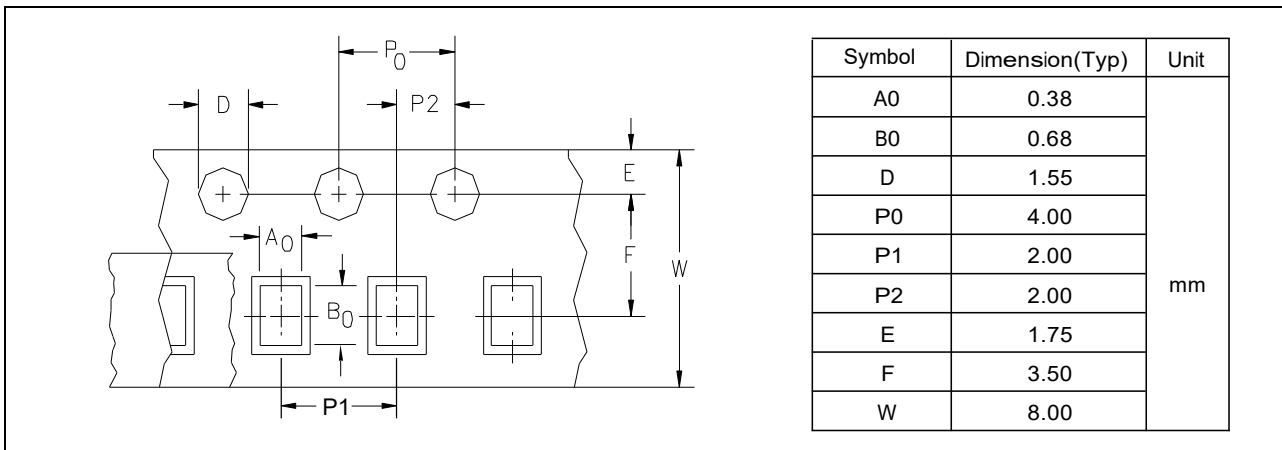

Ordering information

Order code	Package	Packaging option	Base quantity	Packaging specification
YEUP02230R05B	P0201	Tape and reel	15000pcs / reel	EIA STD RS-481